

## BIO-HYDROMECHANICAL INTERCEPTOR AG4

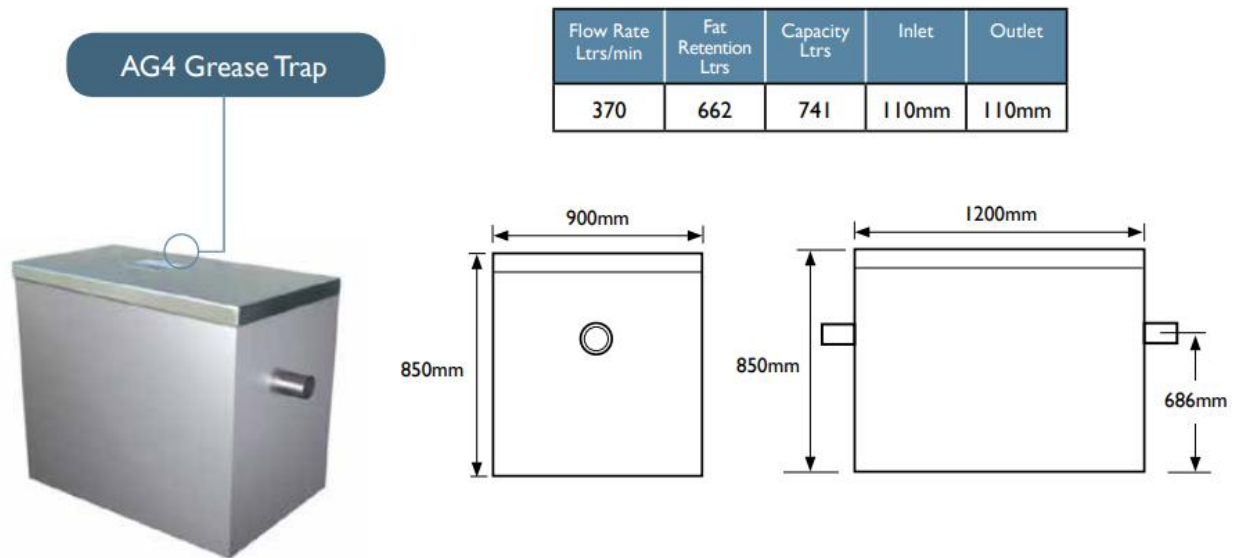

AG4 – Designed for insertion in most store location in hospitality areas

Requires cleaning wrota to suit sinks selected

Would benefit if sink is fitted with Sink Guard filter

Not fitted with filter basket as this aids cleaning & H&S protection

Clips that fasten lid must be accessible

Bio-Dosing can be with DN6 Pump / Devastator

Standard inlet/outlet 50mm fit reducer for 40mm connection [Recommended]

## Contacts

E-mail: [enquiry@alulinegroup.com](mailto:enquiry@alulinegroup.com)

Website: [Welcome To Aluline Ltd : Aluline Ltd \(alulinegms.com\)](http://Welcome To Aluline Ltd : Aluline Ltd (alulinegms.com))

Num: 0044(0)1928563532



This is copyright & design protected